

MACCHINA ASTUCCIATRICE ORIZZONTALE PER CAPSULE DI CAFFÈ
HORIZONTAL CARTONING MACHINE FOR COFFEE CAPSULES

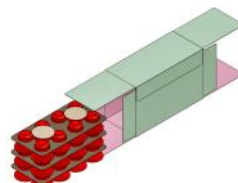
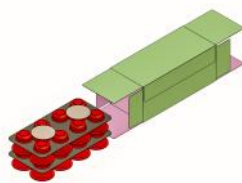
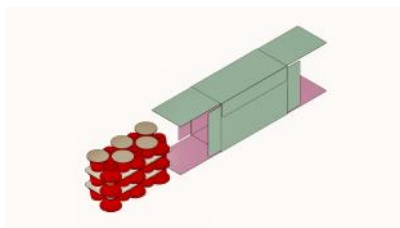
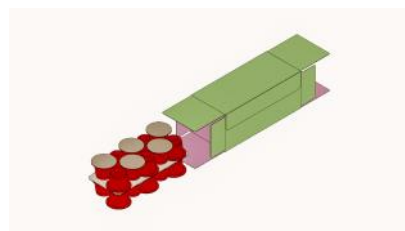
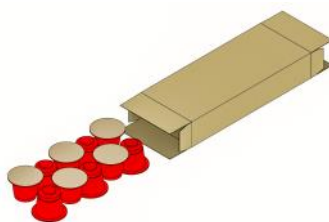
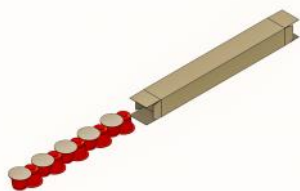
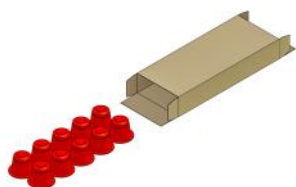

Possibilità di confezionare
le capsule con differenti
configurazioni combinabili
tra di loro

Possibility to pack the
capsules with different
configurations that can be
combined with each other

Macchina astucciatrice orizzontale per confezionare capsule di caffè in plastica, alluminio e compostabili.

La macchina lavora astucci pre-incollati con chiusura lembi a colla tramite incollatore hot-melt.

Alimentazione automatica con abbinamento ad altre macchine riempitrici-saldatrici di capsule.

Macchina a movimenti alternati, con struttura a balcone per permettere un migliore accesso per l'esecuzione delle regolazioni e pulizia.

Possibilità di confezionare le capsule con differenti configurazioni combinabili tra di loro

Il cambio formato molto semplice e veloce, grazie alle regolazioni con indicatori di posizione, senza l'uso di alcun attrezzo.

Gestita da PLC, ha un'interfaccia operatore con touch screen LCD.

Sono disponibili a richiesta vari tipi di optional.

Velocità massima : Fino a 70 astucci/minuto (a secondo del prodotto da confezionare)

Horizontal Cartoning machine capable to pack plastic, aluminium or compostable coffee capsules.

The machine can handle pre-glued cartons. Flap closing is made by Hot Melt glue machine.

Automatic product feeding when linked to other capsule filling-sealing machines.

Intermittent motion machine with structure at balcony style, allowing best access for adjustments and cleaning operations.

Completely mechanical construction for a minimum maintenance.

Possibility to pack the capsules with different configurations that can be combined with each other.

Size change-over is very easy and fast with adjustments made by indicators. No tools are required for the size change.

The machine is PLC controlled and is provided with an operator interface by LCD touch screen.

Different options are available on request.

Maximum speed: up to 70 cartons/minute (according to the product to pack)

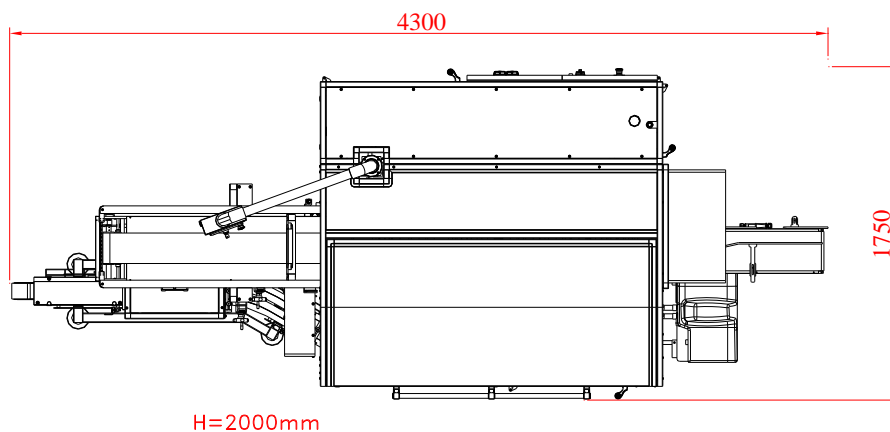

Dimensioni riferite al modello base, modificabile a seconda del tipo di alimentazione e configurazione capsule desiderata

Dimensions refer to the basic model, modifiable according to the feeding and desired capsules configuration

